

**WHERE WE LIVE,  
QUALITY HAS A  
LONG TRADITION**

Founded in 1996, OTEC has quickly established itself as the market's technology leader by developing new machine concepts, inventions and improvements. OTEC supplies machines which are carefully tailored to the needs of specific industries and which are truly impressive in terms of cost-effectiveness, handling and precision and which are far superior to conventional systems. Around 100 members of staff employed at the company's headquarters in Southern Germany and a global sales network ensures excellent worldwide support and outstanding quality at all times.



CF SERIES



SF SERIES



**DRAG FINISHING UNITS  
DF SERIES**



**OTEC Präzisionsfinish GmbH**

Dieselstraße 8-12 · 75334 Straubenhardt-Feldrennach · Germany  
From 01.11.2015: Heinrich-Hertz-Str. 24 · 75334 Straubenhardt · Germany  
Tel. +49 7082 4911-20 · Fax +49 7082 4911-29 · Email: info@otec.de  
[www.otec.de](http://www.otec.de)

# OTEC: WE MAKE THE DIFFERENCE

**Polishing, deburring, rounding or smoothing:**  
We build drag finishing systems to finish any surface quickly and affordably. From small series production to large-scale industrial manufacturing.

The OTEC drag finishing process is predestined for the finishing of large or heavy workpieces which cannot be finished in bulk. The workpieces are clamped in rotating holders and dragged through the process media at high speed. The high contact pressure and relative velocity between the workpiece and the process media gives perfect results in a very short time.

In order to obtain a quality equivalent to manual polishing, the right combination of media, tool holders and process parameters are essential. With 20 years' expertise in the design, construction and the development of efficient processes for our customers all over the world of mass finishing systems, we can truly say – OTEC makes the difference.



DF Tools  
Video about finishing tools



DF knee joint  
Video about finishing knee joints



**Tool holders**  
Polishing improves resistance to corrosion

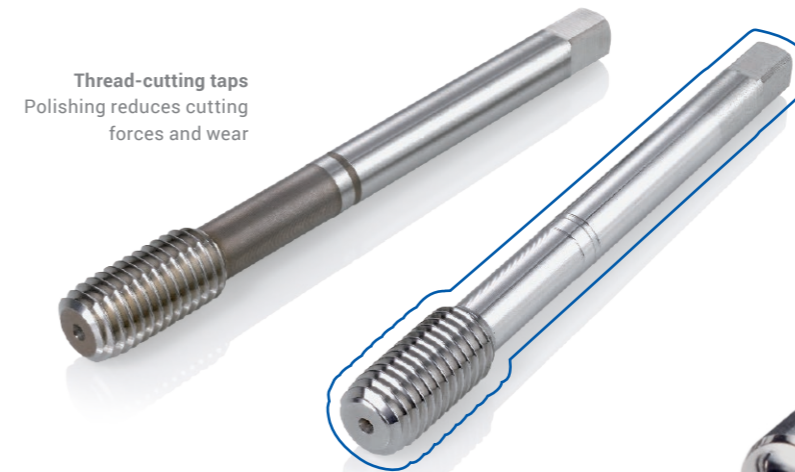

**Thread-cutting taps**  
Polishing reduces cutting forces and wear



**Tableting punch**  
Polishing the contact surface optimizes compacting and improves the quality of tablets



**Burs**  
Rounding the cutting edges increases tool life

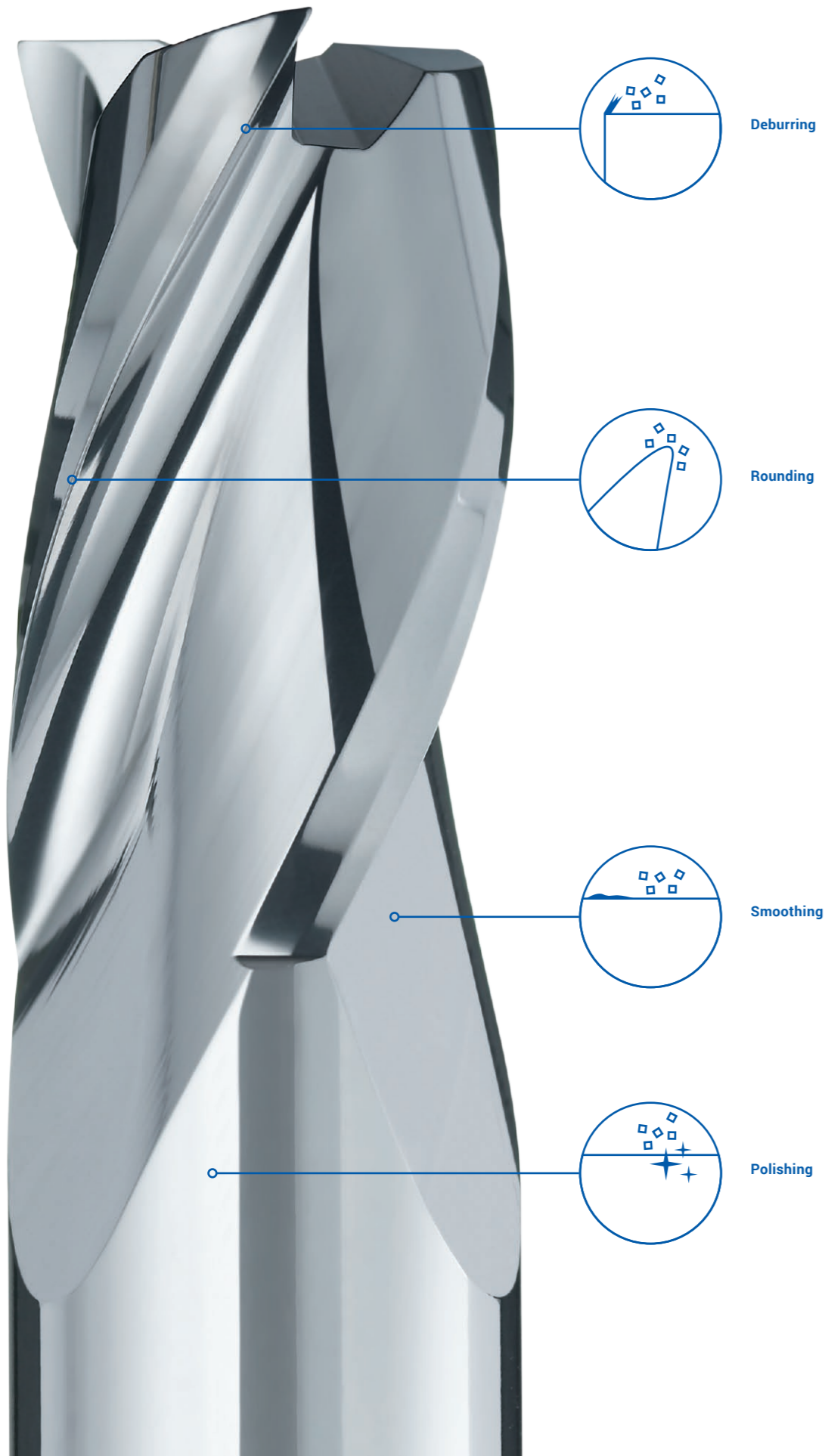

# WE GET YOU TO THE FINISH WITH $\mu$ PRECISION

O TEC-optimized surfaces ensure that workpieces fulfil the high requirements of our customers. The focus here is on the finish or properties of the surface. In series production, reliably repetitive results and cost-effectiveness deliver a real competitive edge.

## Deburring

Residual burring and swarf from the manufacturing process on the edges and surfaces impair the quality of a workpiece. By choosing the right media and the right process, these blemishes can be removed to give trouble-free downstream finishing and better handling.

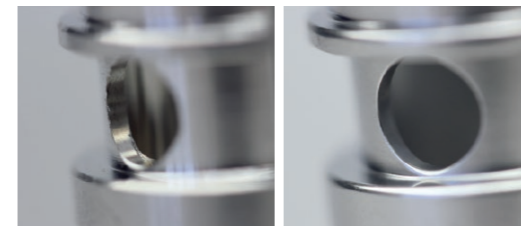

Example: before with burring, after completely free of burrs

## Smoothing

With smoothing, the roughness of the surface is reduced, i.e. the unevenness in the peaks on the surface are removed. The benefits this brings include reduced friction, higher contact ratios and less wear. A further benefit is the removal of droplets after PVD coating.

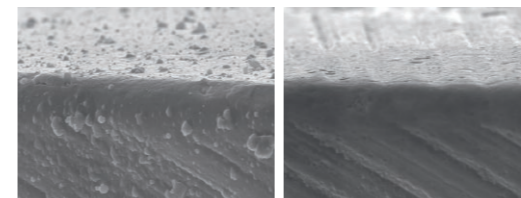

Example: droplets before and after finishing

## Rounding

Edges are generally rounded in order to improve the reliability of a workpiece. A rounded edge is free of burrs, has no secondary burring and is therefore less susceptible to wear and chipping.

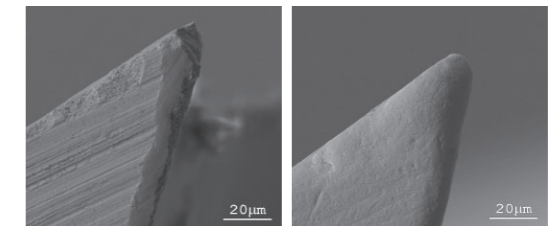

Example: cutting edge before and after finishing

## Polishing

In addition to improving the appearance of the workpiece surface, polishing also improves the physical properties of the surface. For example, an absolutely smooth and scratch-free surface increases the life of implants and in the case of cutting tools, a polished chip flute gives higher maximum cutting speeds.



Example: highly polished surface, Ra 0.01  $\mu$ m

## WHERE QUALITY IS INSIDE, QUALITY COMES OUT



OTEC DF 5 Tools HD

With its DF series, OTEC offers a versatile range of drag finishing machines. Whether for small or large series production, every single machine fulfils the most demanding requirements in terms of cost-effectiveness and precision.

When you opt for an OTEC DF system, you are choosing unparalleled quality made in Germany – at a fair price. Top-quality materials guarantee long service life and a proven design concept ensures ergonomic and efficient handling.

The extensive standard equipment supplied and the wide range of modular add-ons make each unit future ready. For example, the process drums are made from stainless steel. In addition, up to 500 programs (expandable) can be stored and backed up onto a USB stick.

Optional modules are available to make each system even more user-friendly and reliable: for example, fully automatic or manual immersion depth control is available as an optional extra to program and regulate the ideal immersion depth of the workpiece. Process container cooling is available in order to keep the polishing granulate at a constant temperature and ensure maximum processing speeds.

Machines for wet finishing are equipped with a dosing regulator which enables the water flow and the concentration of the compound to be controlled via the touch panel.



### Touch display

User-friendly control and programming of process parameters and – optionally – of the immersion depth.



### Dual motor drive

With the dual motor drive, the speed of the rotor and of the workpieces can be set independently of each other. This enables the machine to be fine-tuned to the exact requirements of the workpiece.

## GENUINE COMPONENTS FOR A GENUINE SYSTEM

**Machine + holder + process + workpiece. The whole is more than the sum of the parts. In order to deliver perfect results, holders and machines must be tested together and carefully coordinated.**

Our OTEC workpiece holders make a significant contribution to the perfect processing results obtained by the DF series.

OTEC's proprietary tool holders ensure that the workpieces are mounted as quickly and effectively as possible and considerably speed up batch processing. In recent years, we have designed over 100 different types of holder in close cooperation with our customers. In particular, optional features such as laser-operated immersion depth control benefit the absolute compatibility of holder and machine.

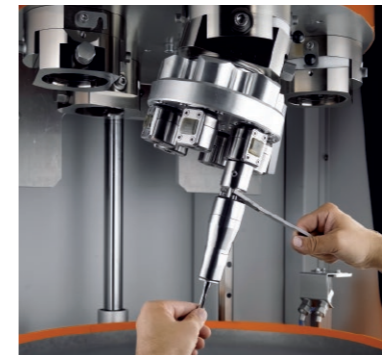

### Independently driven angled holder

Optionally available with the holder adjustable at an angle for finishing end surfaces and complex geometries.



### Rigid holder

Rigid holder with quick tool changer



### Quick tool changer

This system enables tools such as drills and burs to be changed in seconds by means of lever.



### Customized holders

On request, we can develop special tool holders to meet your specific requirements.

**THE QUALITY SERIES FOR SERIES QUALITY**

**TECHNICAL SPECIFICATIONS**



	DF 3/4	DF 5/6	DF 7	DF 10	DF 40	DF 80
Machine dimensions (w x d x h mm)	1180 x 970 x 2010	1380 x 1150 x 2010	1740 x 1360 x 2680	1740 x 1360 x 2680	1124 x 848 x 1972	1344 x 1050 x 1972
Working capacity of drum (liters)	80	114	200	200	60	95
Maximum immersion depth (mm)	250	250	250	250	250	250
Weight (kg)	310-325	780-810	1700	1600	322	530
Voltage (V)	400	400	400	400	230	230
Output depending on configuration (kVA)	7,5	11	15	11	2,5	3
Holder positions	3/4	5/6	7	10	3	5
Maximum workpiece diameter (mm)	250/210	250/210	250	200	250/210	250/210
Maximum workpiece weight (kg)	15	15	15	15	15	15

Adapter positions with 3/4/6 head driven holder	DF 3: 9/12/18 DF 4: 12/16/24	DF 5: 15/20/30 DF 6: 18/24/36	21/28/42	30/40/60	9/12/18	15/20/30
Maximum workpiece diameter with 3/4/6 head driven holder (mm)	90/85/55	90/85/55	90/85/55	65/65/55	—	—
Maximum workpiece weight with 3/4/6 head driven (kg)	2,0/1,5/0,5	2,0/1,5/0,5	2,0/1,5/0,5	2,0/1,5/0,5	—	—



**DF PHARMA series**

Specially developed to meet the requirements of the pharmaceuticals and food industries.



**DF 5 TOOLS series**

The solution for finishing tools in large-scale industrial production.



**DF 7 WET series**

Drag finishing machine for grinding and polishing workpieces in wet media.



**DF 3 WET series**

Ideally suited to finishing tools in small to medium production runs.



**DF 10 TOOLS**

With 10 workpiece holders, the first choice for finishing tools in very large quantities.



**Special machines**

Custom-built to your process requirements with our extensive experience and at a fair price.

## WE REINVENT OURSELVES, JUST FOR YOU



Example: customized machine: DF 5/330 with a drum diameter of 1100 mm

Do you have exceptional requirements for which there is not yet a solution on the market? Speak to us. As the technology leader in innovative drag finishing machines, special solutions made to our customers' specifications are our particular strength. We work closely with you to develop a highly customized solution, including the most suitable process. Our team will be pleased to advise you without any cost or obligation on your part and in absolute confidence. Call us: 07082 4911-20

## MACHINE AND PROCESS – THE DUAL SOLUTION

Every workpiece is different. For a reproducible and efficient process which always results in a perfect surface, all relevant parameters are determined and documented in the lab.

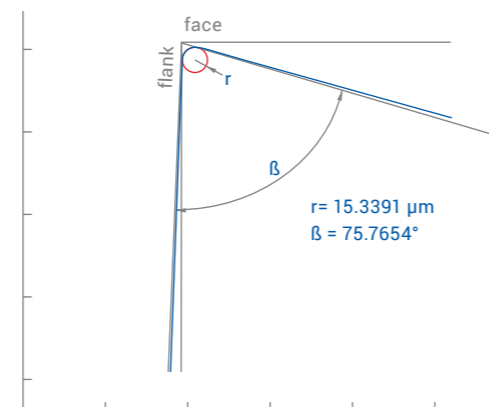

The measurement log shows the surface quality of the edge rounding in the  $\mu\text{m}$  range.

Our OTEC research lab offers you a professional service and can develop a process fine-tuned to your workpiece and your application.

After processing a sample, we first create a log documenting all process parameters. On the basis of this information, the details of stock removal, quality of finish, surface compaction and other technical data are clear to see. This provides valuable insights which subsequently enable us to determine the combination of grinding and polishing media that is right for you.

Alternatively, we can also advise you without finishing a sample if you send us a high-quality photo of your workpiece. If you order a machine, the process log relating to your application is, of course, free of charge.

### Example of a process log

<b>Task:</b>	grinding and polishing	<b>Clockwise:</b>	50 %	<b>Additional drive:</b>	✓
<b>Material:</b>	titanium	<b>Counter-clockwise:</b>	50 %	<b>Holder:</b>	Angled holder 3-way 7
<b>Manufacturing process:</b>	casting				

### Machine: DF 5 Wet

Process stage 1	Time	Process	Media	Compound	Rotor speed	Holder speed
	45 min	wet grinding	DBS 6/6 ceramic chips	SC 15 compound	35	100
Process stage 2	Time	Process	Media	Compound	Rotor speed	Holder speed
	60 min	wet grinding	KM 6 plastic chips	SC 15 compound	45	40
Process stage 3	Time	Process	Media	Compound	Rotor speed	Holder speed
	30 min	dry polishing	M5/300 corn granulate	PP 04 polishing powder	45	40